

ANEXO D

**PLANTAS ESTRUCTURALES
HOSPITAL BASE DE PUERTO MONTT**

HOSPITAL DE PUERTO MONTT

CUERPO C

PLANTA ESTRUCTURAL PISO I

SIMBOLOGIA

- elemento de hormigon armado
- muros de albañileria $\phi > 0.30$ m.
- muros de albañileria $\phi = 0.20$ m
- vigas

- X eje longitudinal
- Y eje transversal
- centro de gravedad
- A centro de Haldre

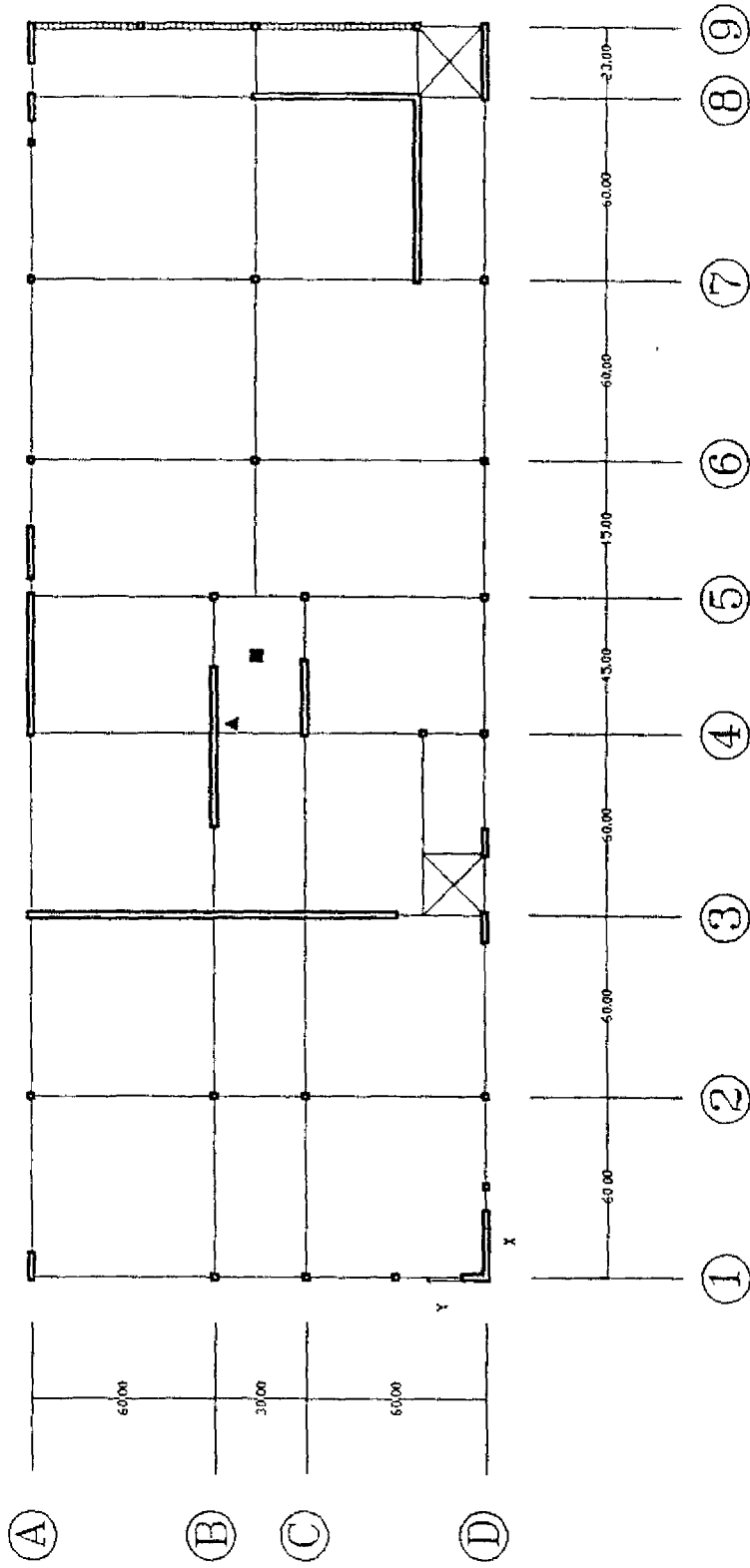









HOSPITAL DE PUERTO MONTT

CUERPO D

PLANTA ESTRUCTURAL PISO 1

SIMBOLOGIA

-  elemento de hormigón armado
-  muros de albanilería e > 0,30 m
-  muros de albanilería e = 0,20 m.
-  vigas
-  eje longitudinal
-  eje transversal
-  centro de gravedad
-  centro de rigidez

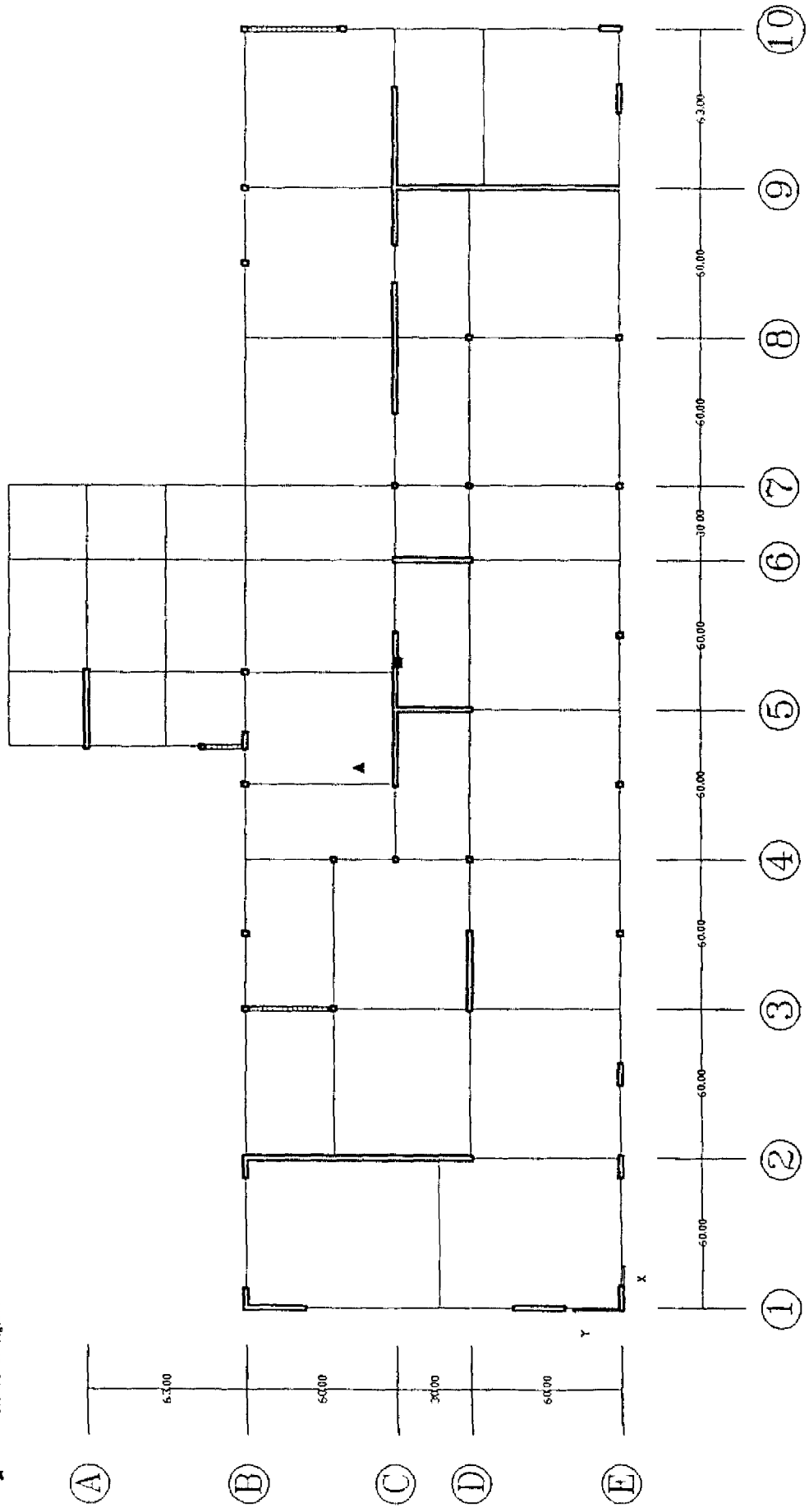









HOSPITAL DE PUERTO MONTT

CUERPO E1

PLANTA ESTRUCTURAL PISO 1

SIMBOLOGIA

-  : elemento de hormigón armado
-  : muros de albañilería > 0.20 m
-  : muros de albañilería < 0.20 m
-  : Vigas
-  X : eje longitudinal
-  Y : eje transversal
-  ■ : centro de gravedad
-  ▲ : centro de rigidez

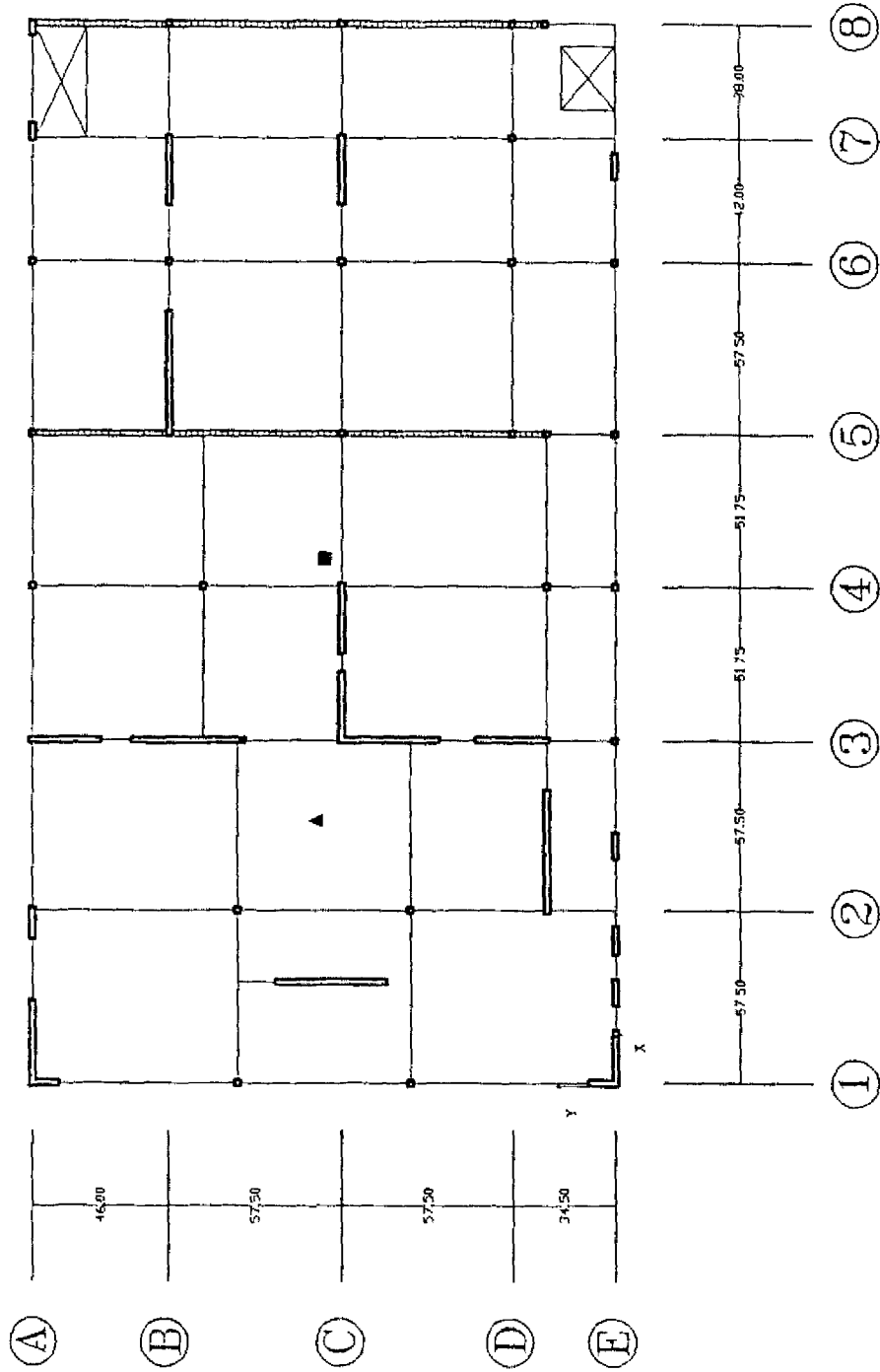









HOSPITAL DE PUERTO MONTT

CUERPO E2

PLANTA ESTRUCTURAL PISO 1

SIMBOLOGIA

-  elemento de hormigón armado
-  muros de albañilería e > 0.30 m.
-  muros de albañilería e = 0.20 m.
-  vigas
-  X eje longitudinal
-  Y eje transversal
-  ■ centro de gravedad
-  ▲ centro de rigidez

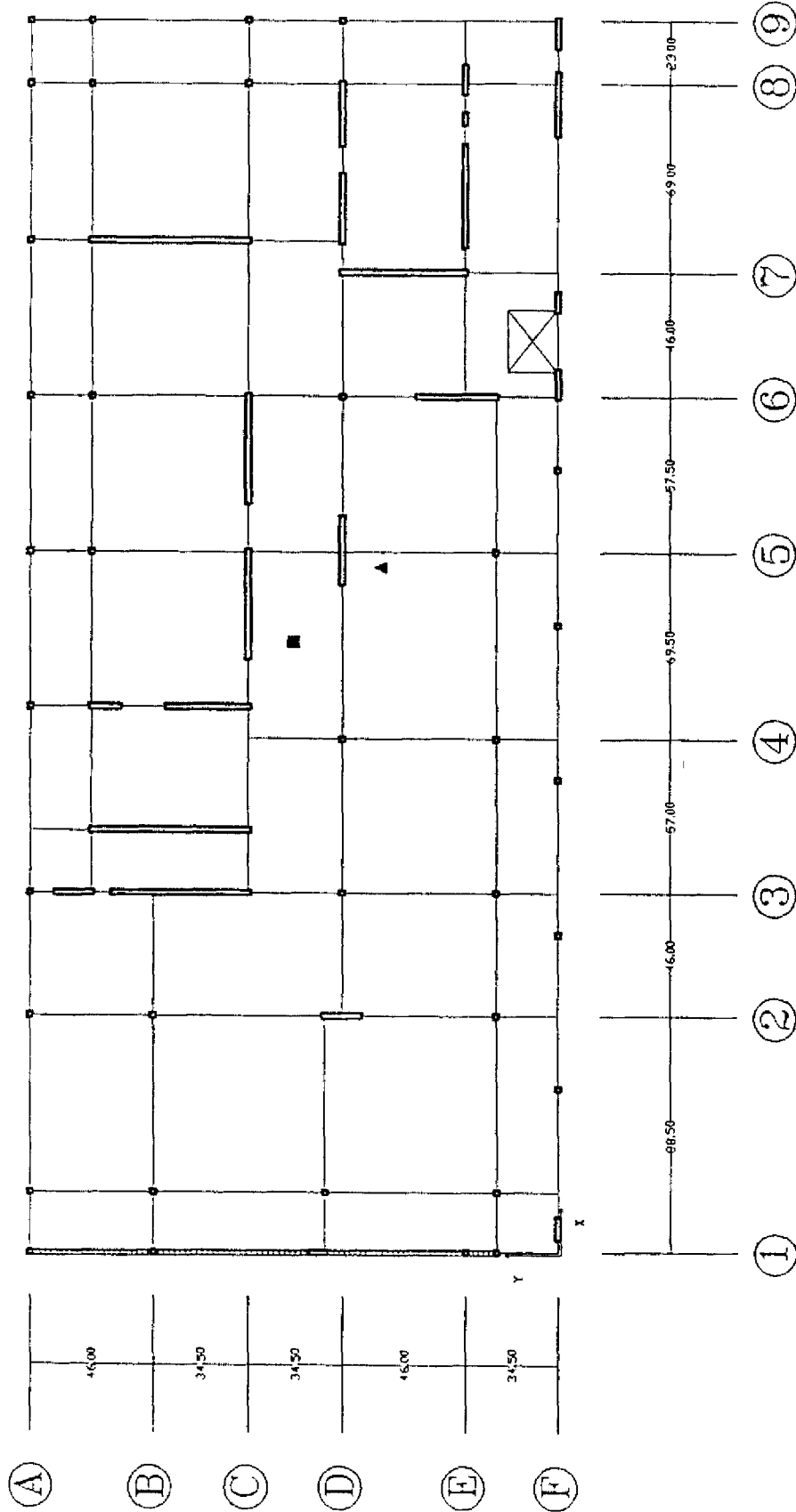

HOSPITAL DE PUERTO MONTT

CUERPO K

PLANTA ESTRUCTURAL PISO 1

SIMBOLOGIA

- elemento de hormigón armado
- muros de albañilería > 4.50 m
- muros de albañilería < 4.50 m
- agua

- X eje longitudinal
- Y eje transversal
- centro de gravedad
- ▲ centro de rigidez

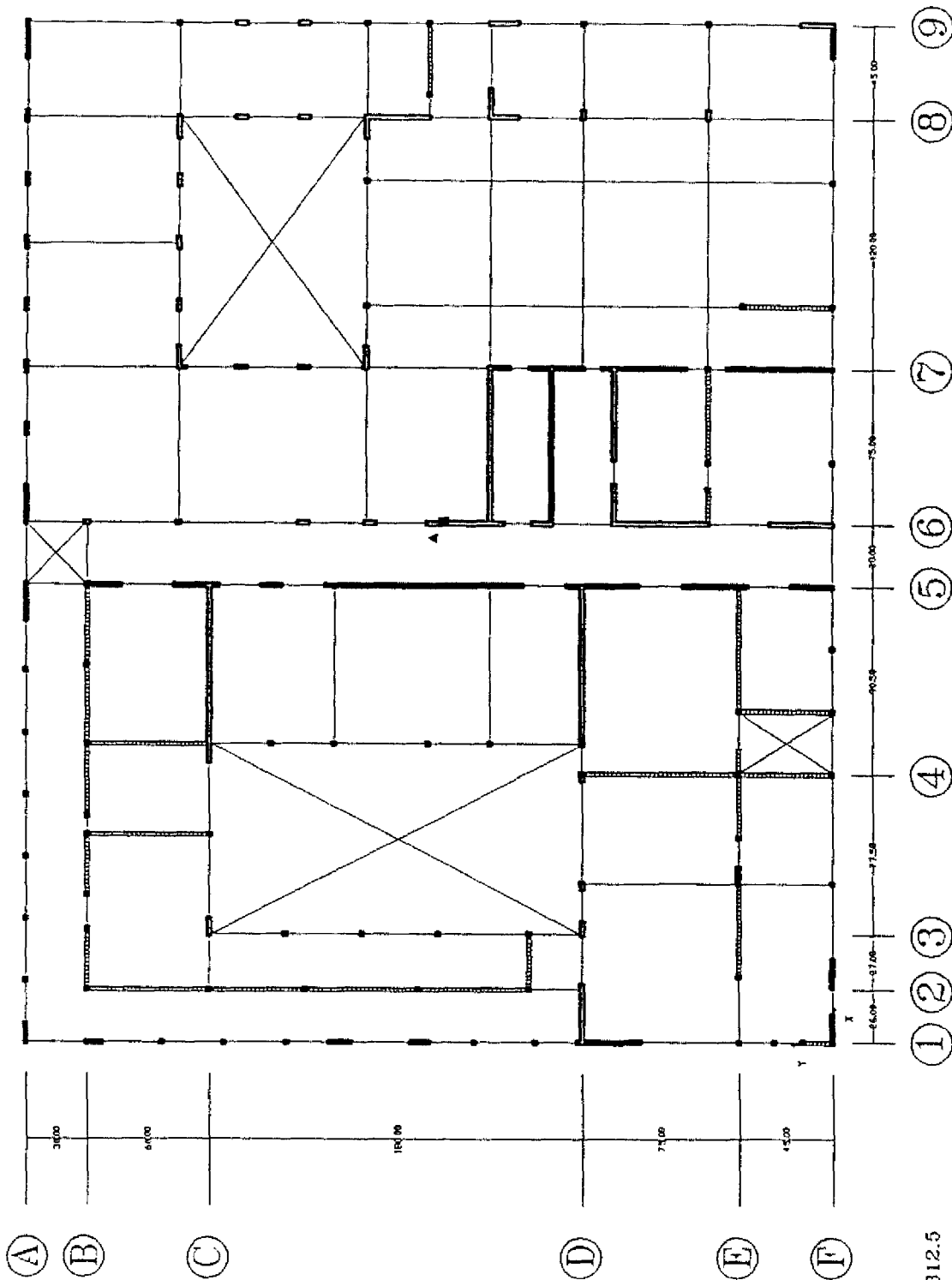

ESCALA 1 : 312.5



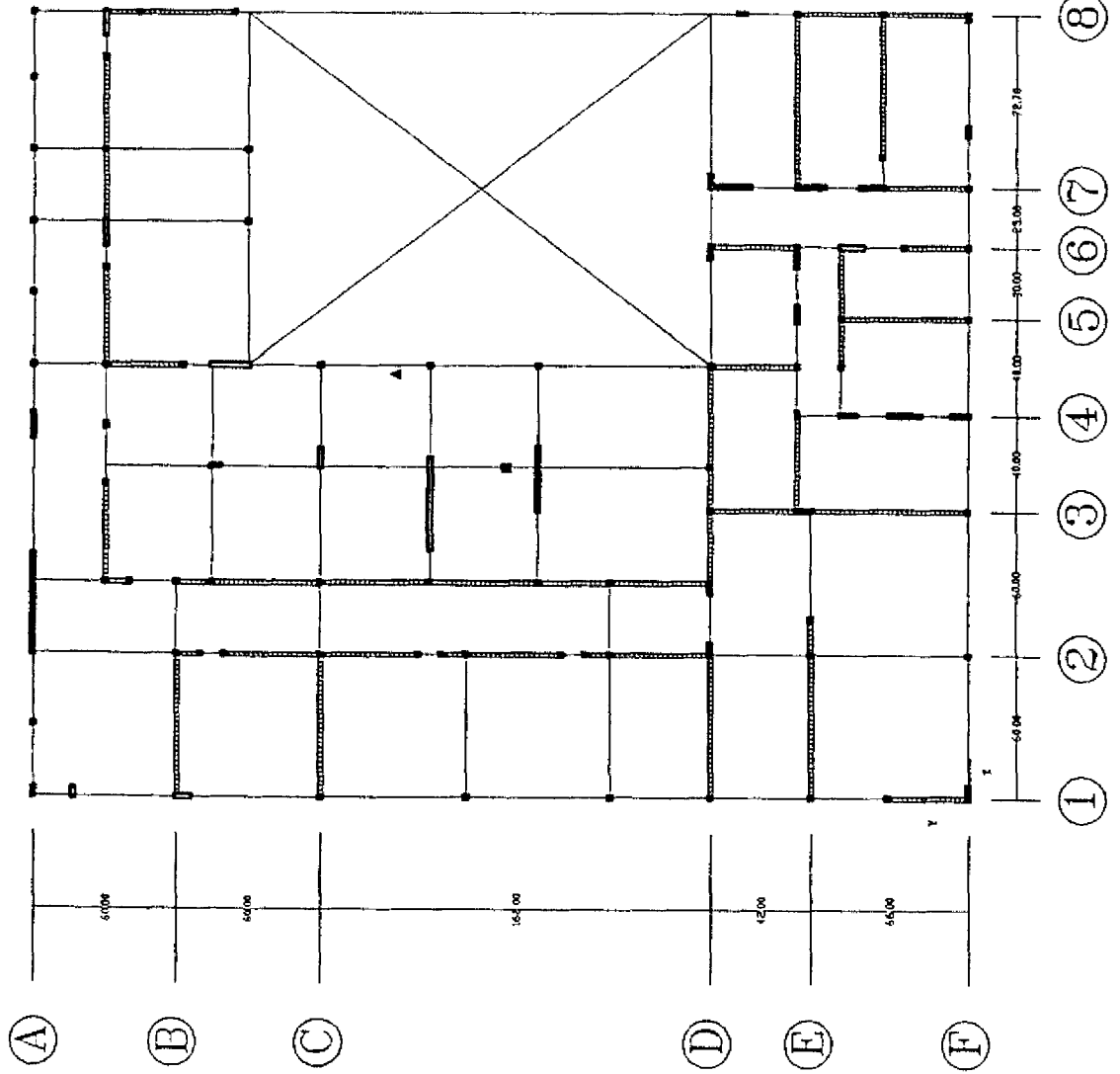

HOSPITAL DE PUERTO MONTT

CUERPO L

PLANTA ESTRUCTURAL PISO 1



SIMBOLOGIA

-  : elemento de hormigón armado
-  : muros de albañilería > 0.20 m.
-  : muros de albañilería < 0.20 m
-  : ejes

- X : eje longitudinal
- Y : eje transversal
- : centro de gravedad
- A : centro de rigidez









ESCALA 1 : 312.5

HOSPITAL DE PUERTO MONTT

CUERPO M

PLANTA ESTRUCTURAL PISO I

SIMBOLOGIA

-  elemento de hormigon armado
-  muros de albanileria e > 0.30 m.
-  muros de albanileria e = 0.20 m.
-  vigas
-  eje longitudinal
-  eje transversal
-  centro de gravedad
-  centro de rigidez

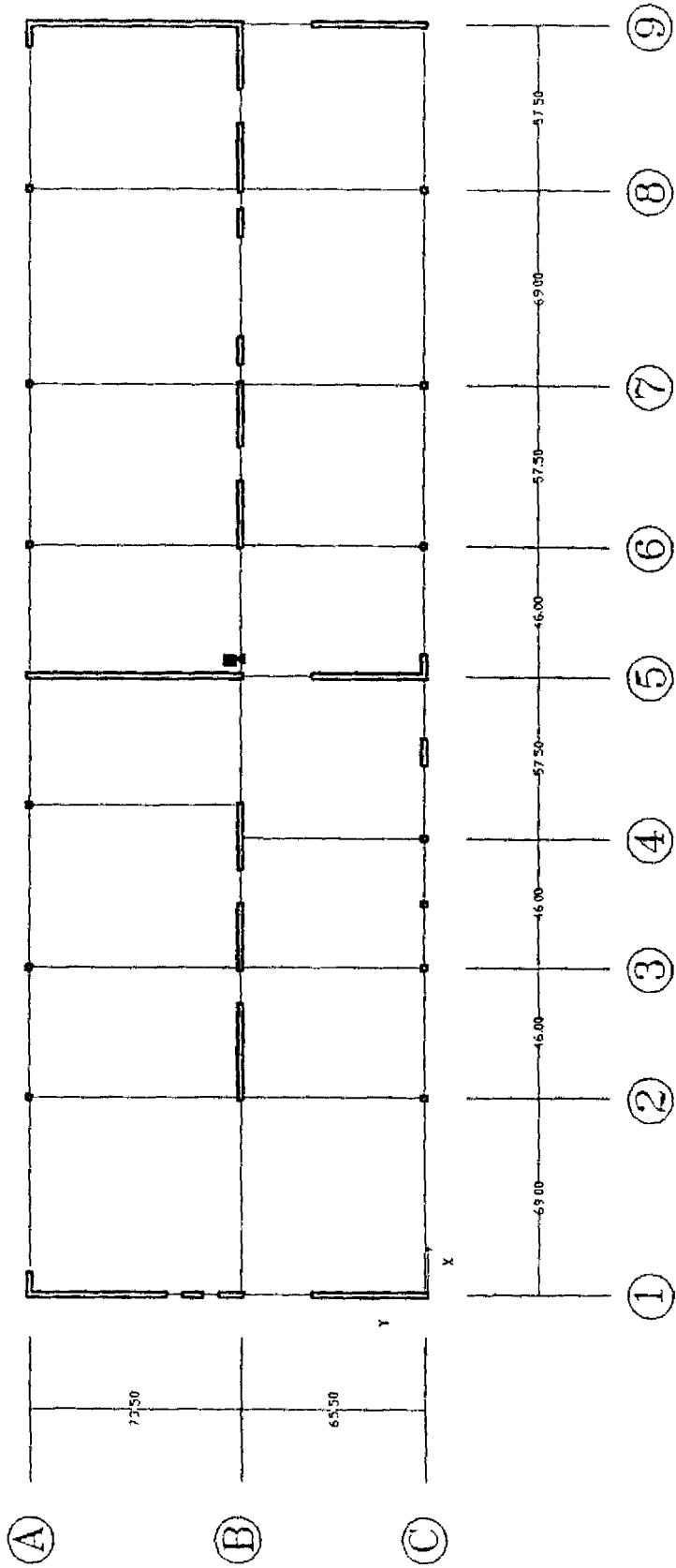

ANEXO E

**ELEVACIONES DE EJES
HOSPITAL BASE DE PUERTO MONTT**

HOSPITAL DE PUERTO MONTT
CUERPO C

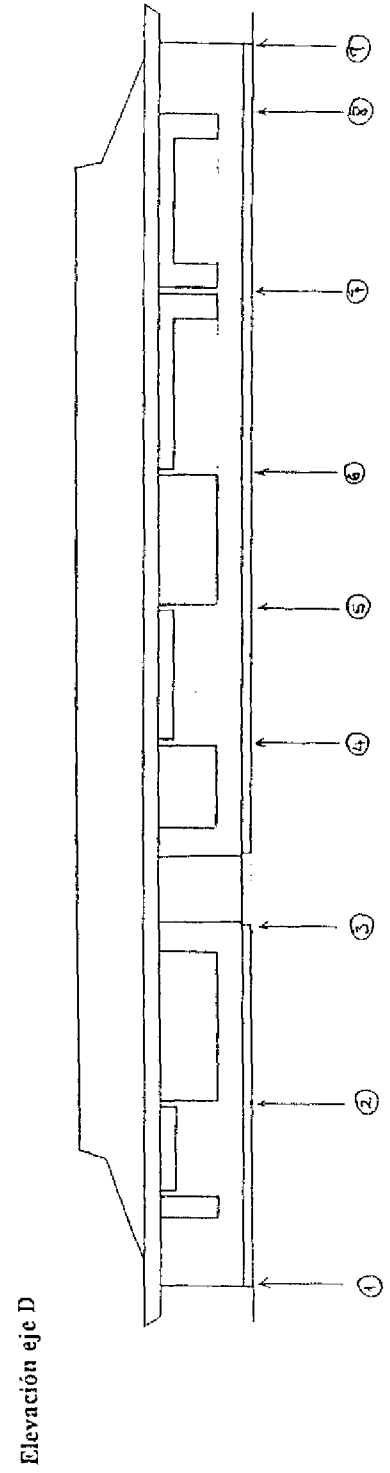
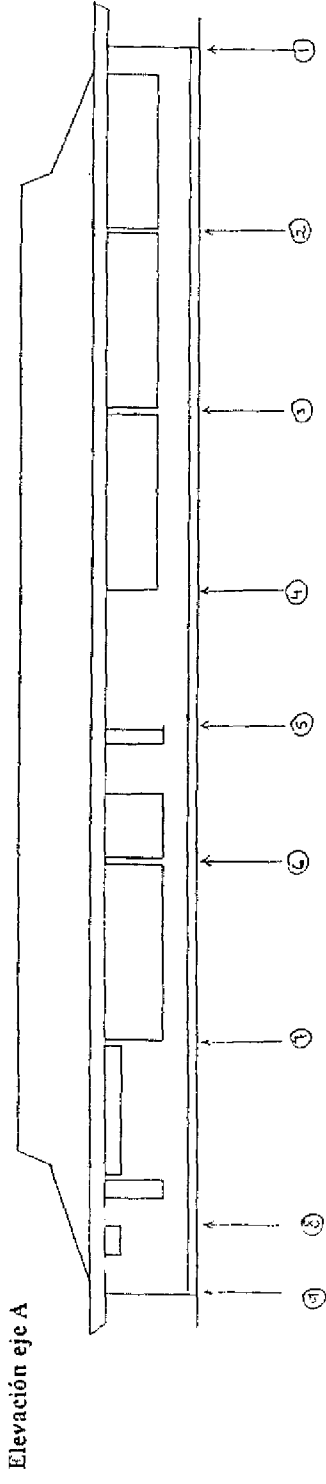

HOSPITAL DE PUERTO MONIT
CUERPO C

Elevación eje 1

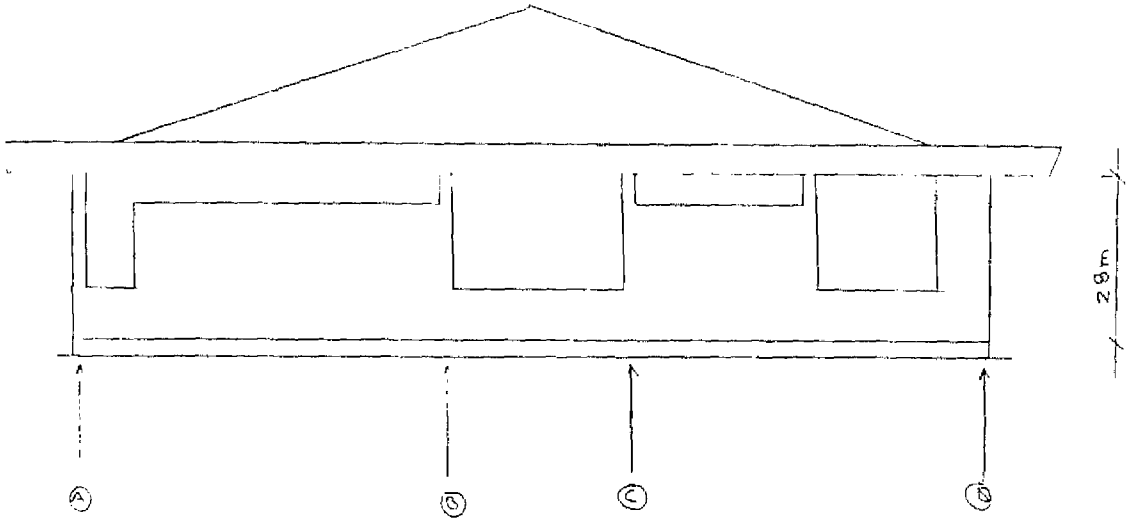

Elevación eje 9

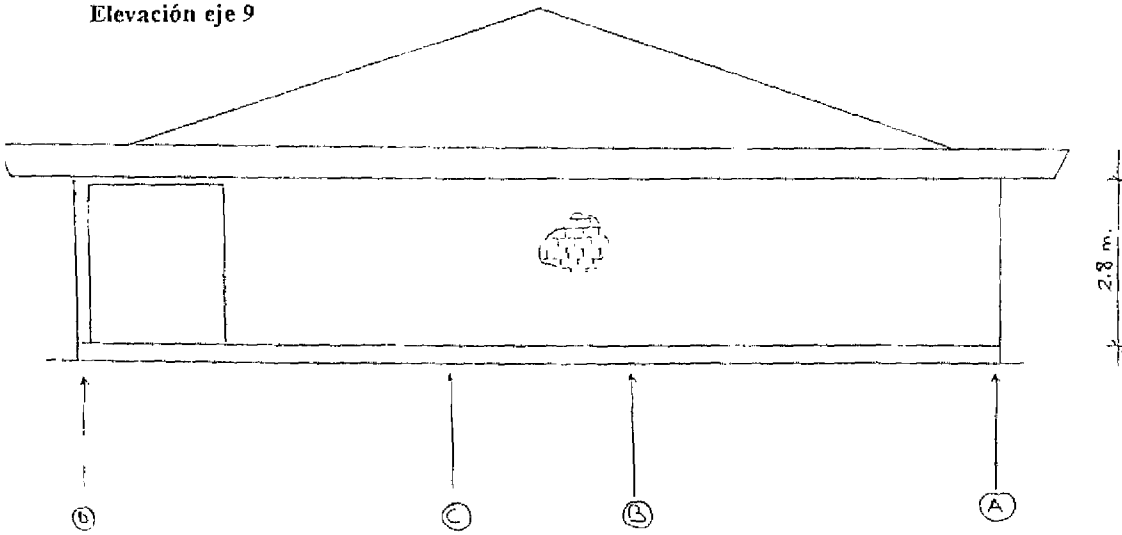

HOSPITAL DE PUERTO MONTE

CUERPO D

Elevación eje B

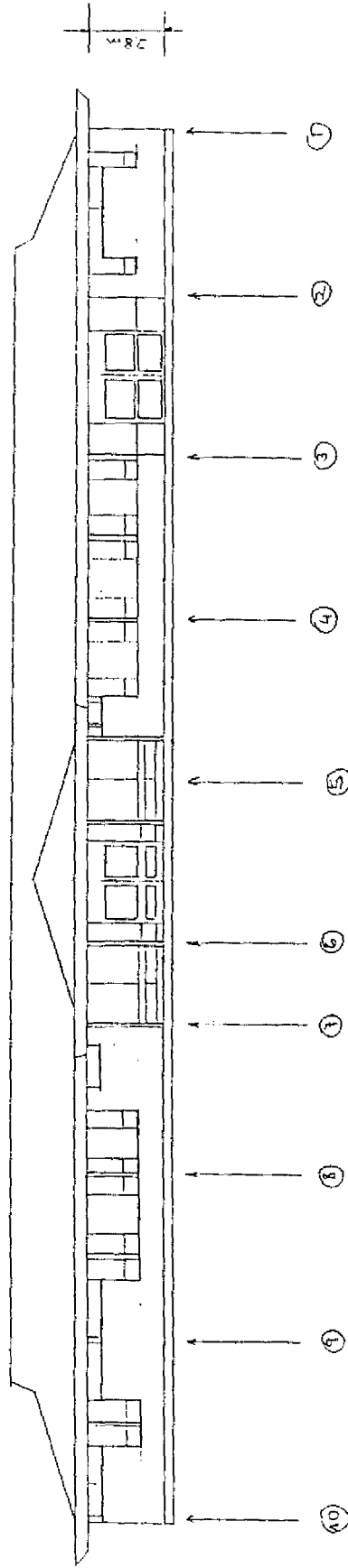

HOSPITAL DE PUERTO MONTT

CUERPO D

Elevación eje E

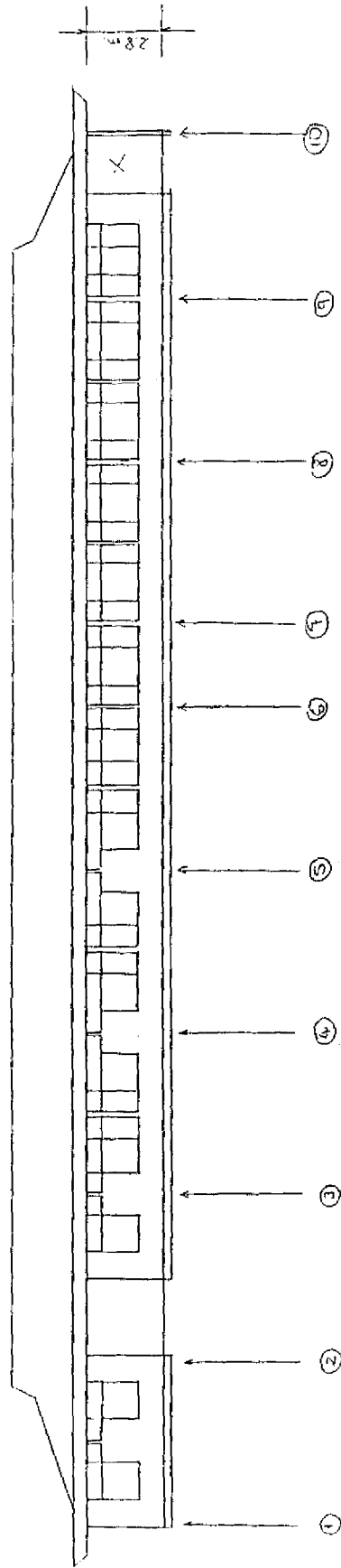

HOSPITAL DE PUERTO MONTT

CUERPO D

Elevación eje 1

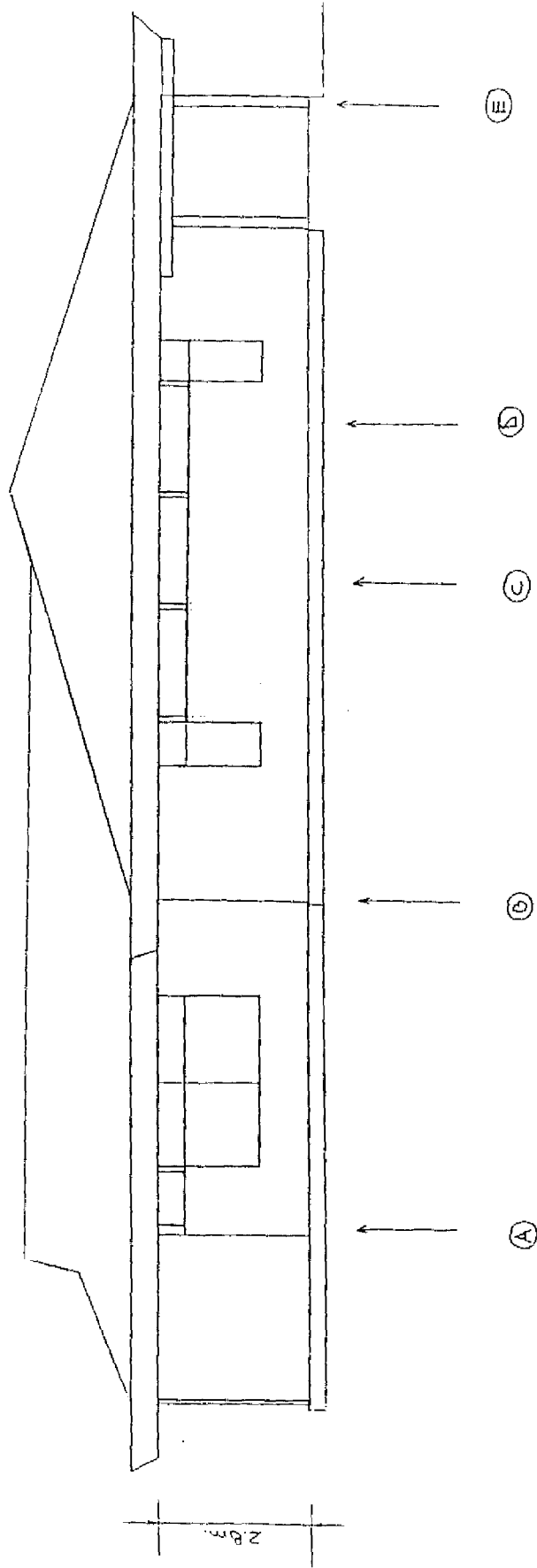

HOSPITAL DE PUERTO MONTT

CUERPO D

Elevación eje 10

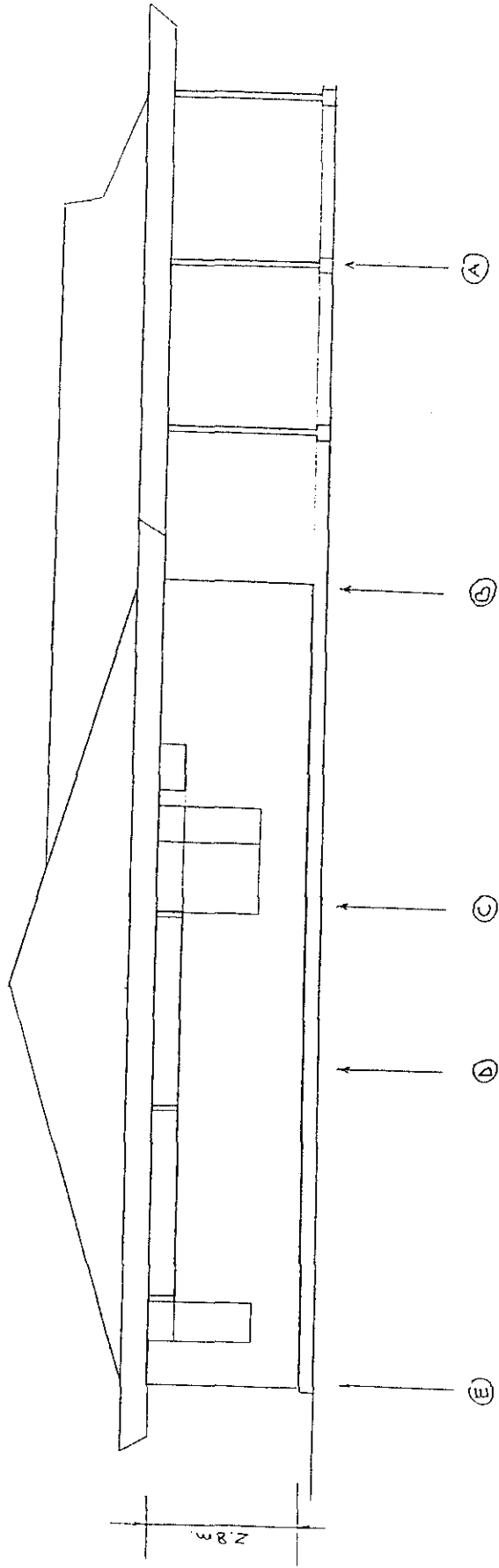

HOSPITAL DE PUERTO MONTT
CUERPO E1

Elevación eje A

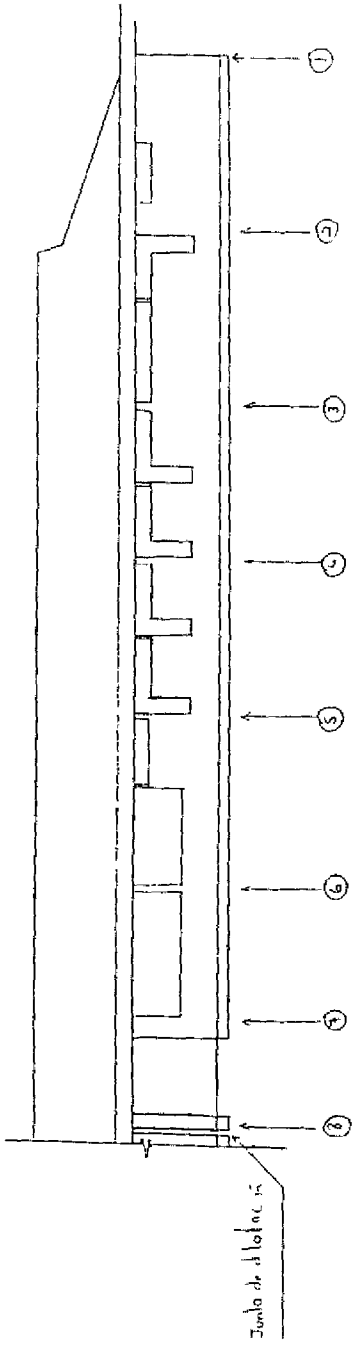

Elevación eje G

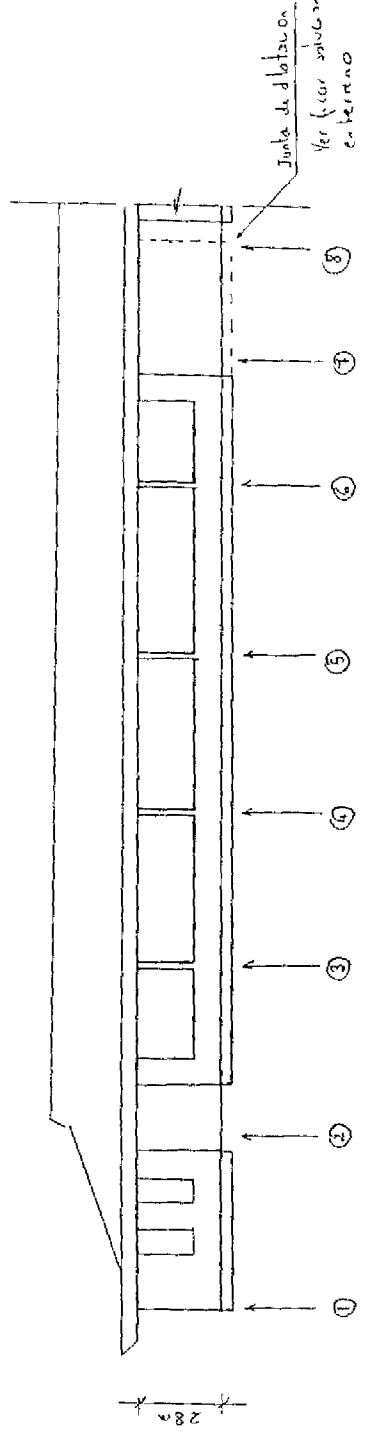

HOSPITAL DE PUERTO MONTT
CUERPO E2

Elevación eje A

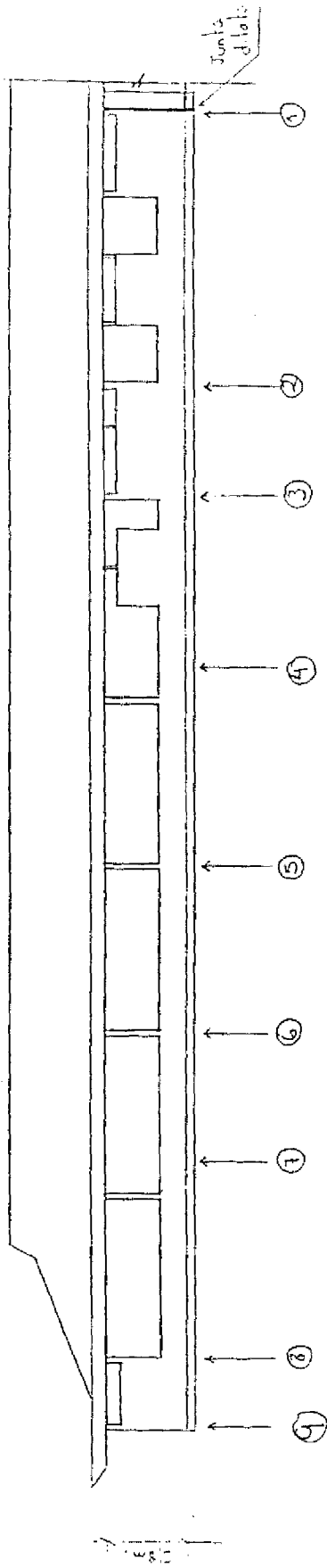

Elevación eje G

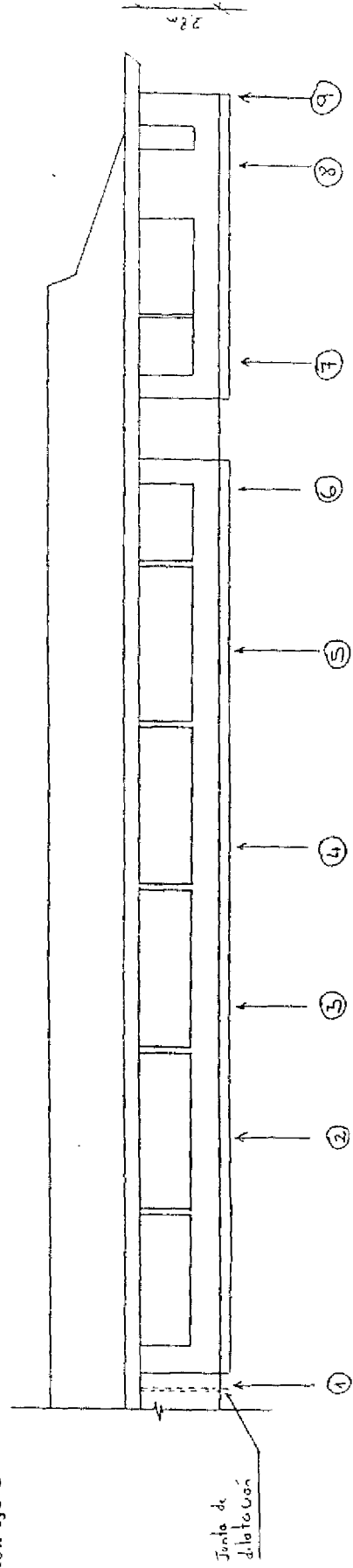

HOSPITAL DE PUERTO MONTT

CUERPO E2
Elevación eje 9

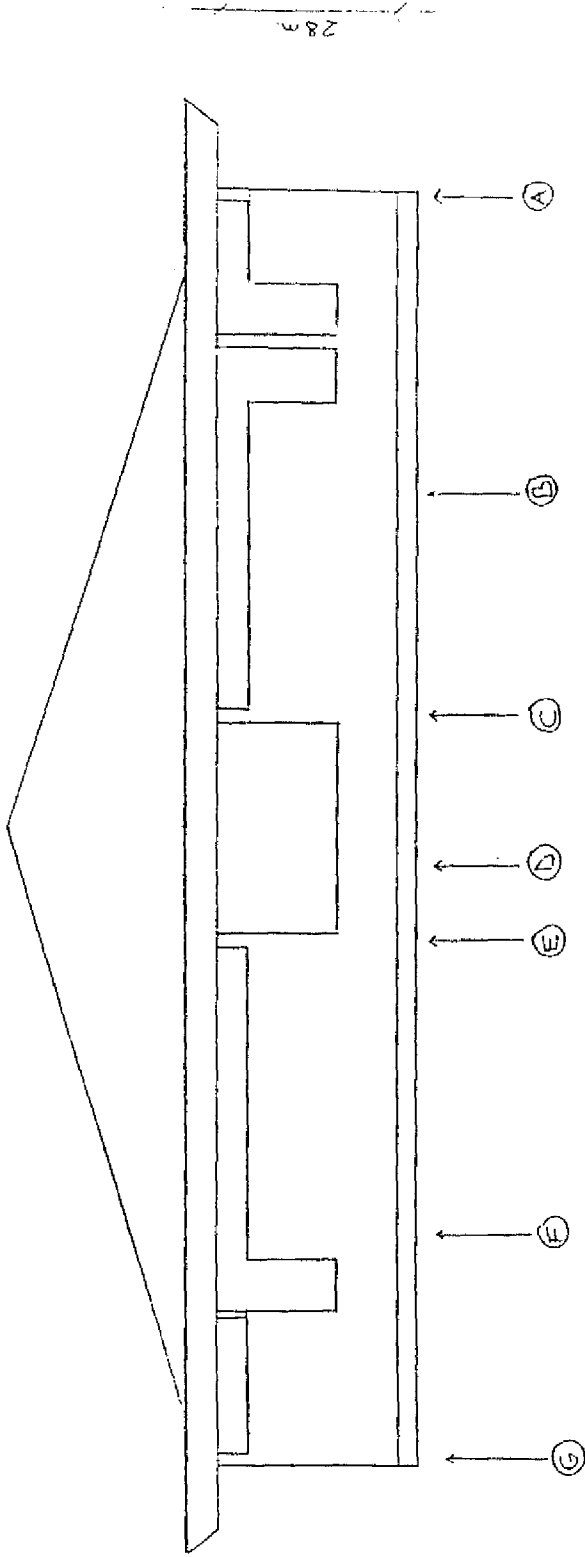

CUERPO E1
Elevación eje 1

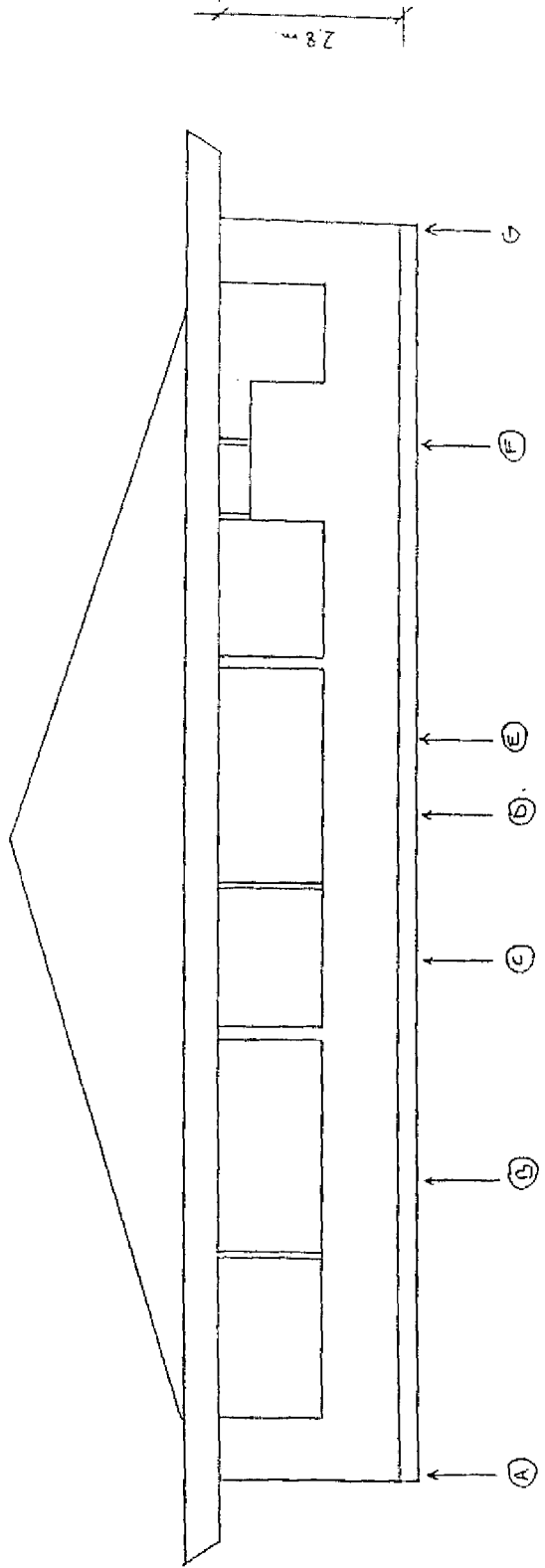

HOSPITAL DE PUERTO MONTT
CUERPO K

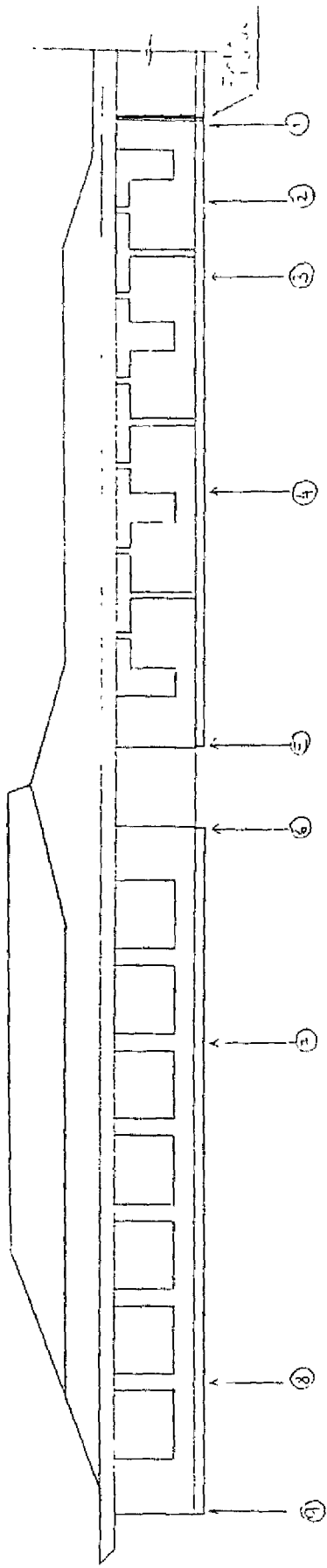

Elevación eje A

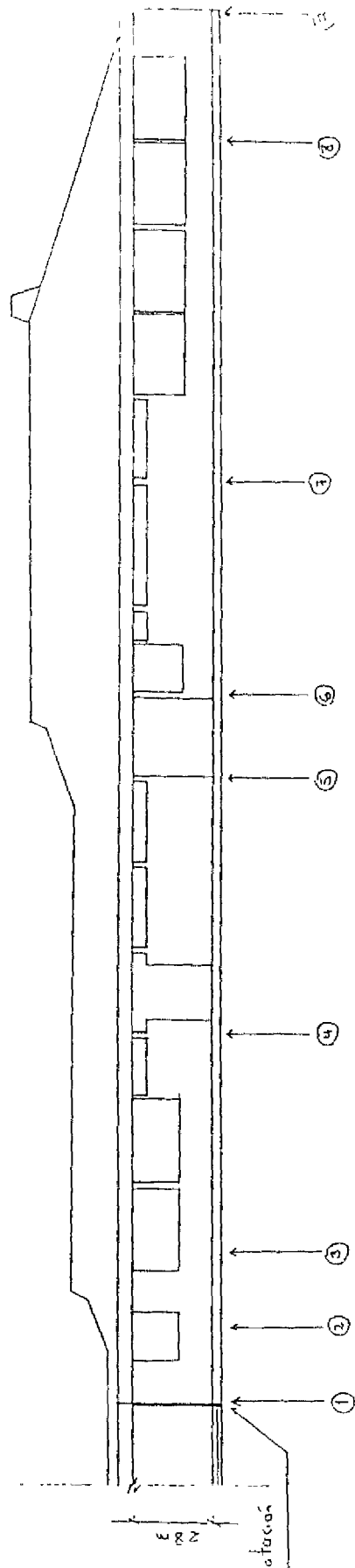

Elevación eje F

HOSPITAL DE PUERTO MONTT
CUERPO K

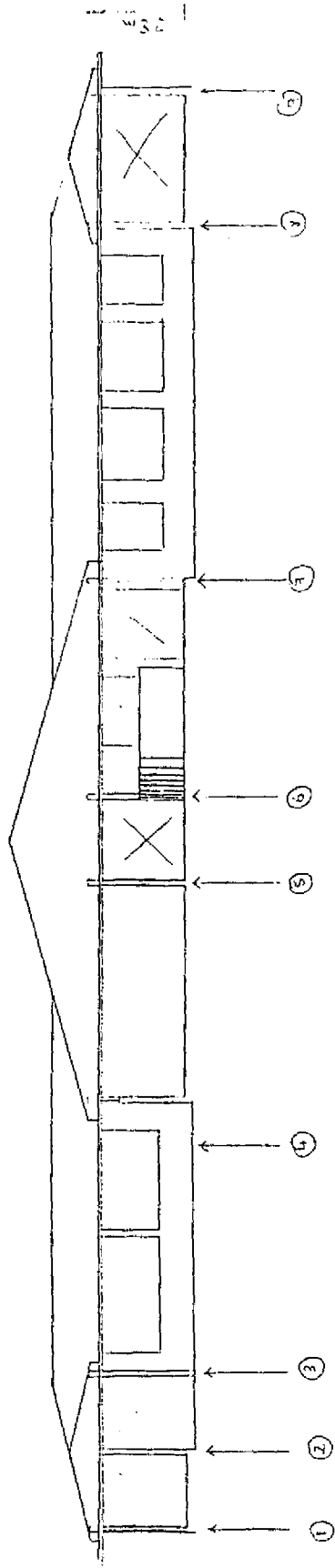

Elevación corte A-A'

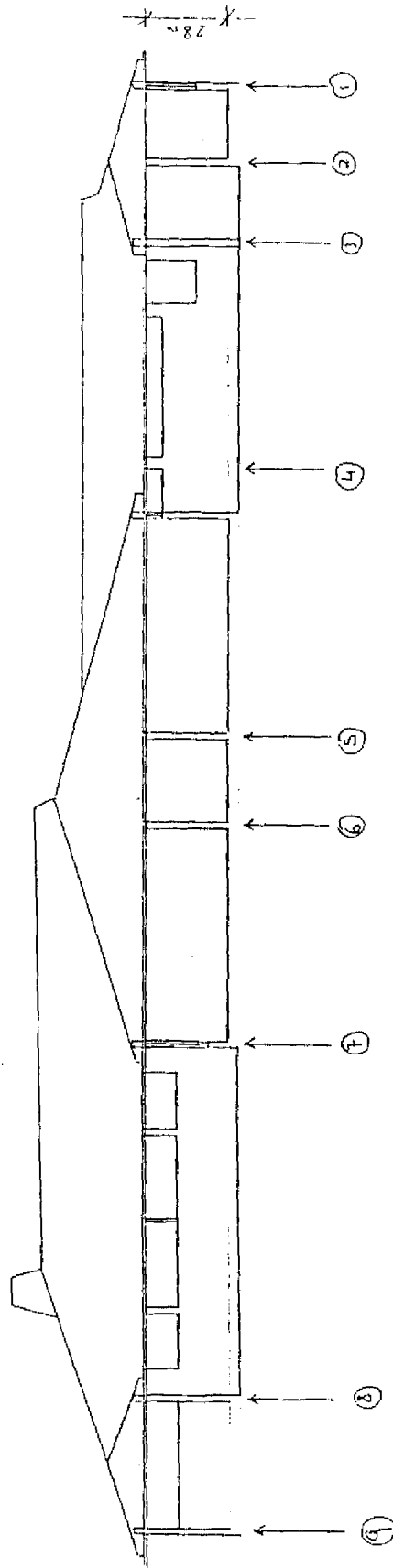

Elevación corte B-B'

HOSPITAL DE PUERTO MONTT
CUERPO K

Elevación corte D-D'

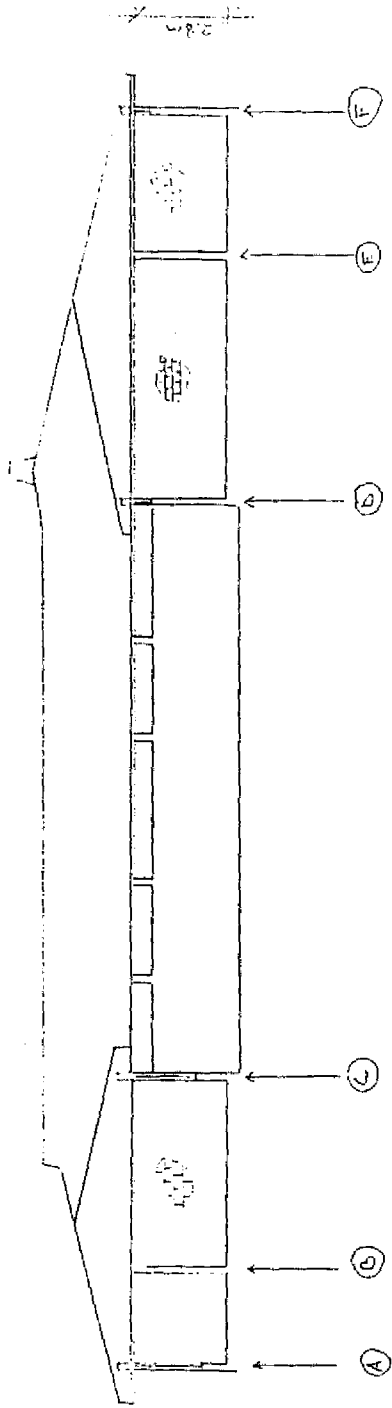

Elevación corte C-C'

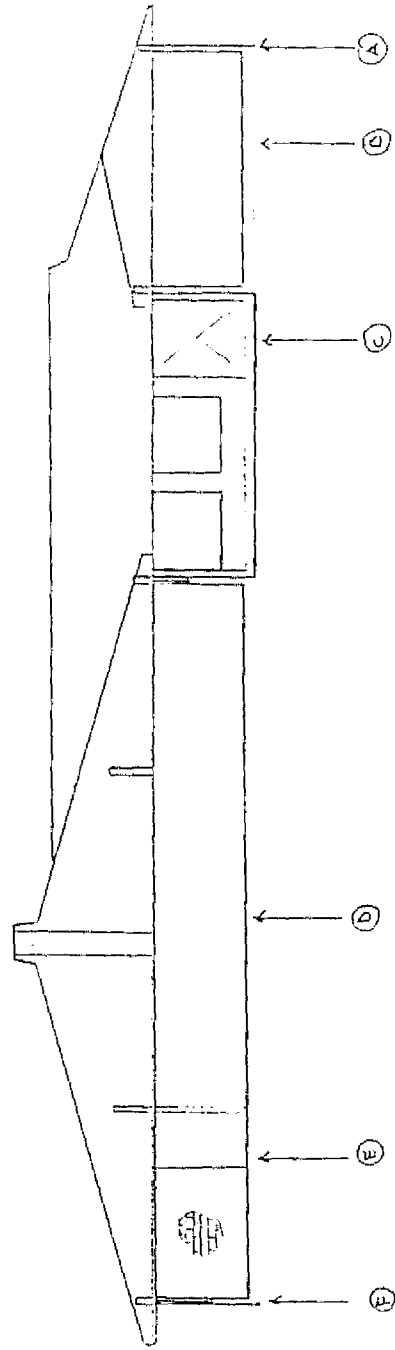

HOSPITAL DE PUERTO MONTT
CUERPO K

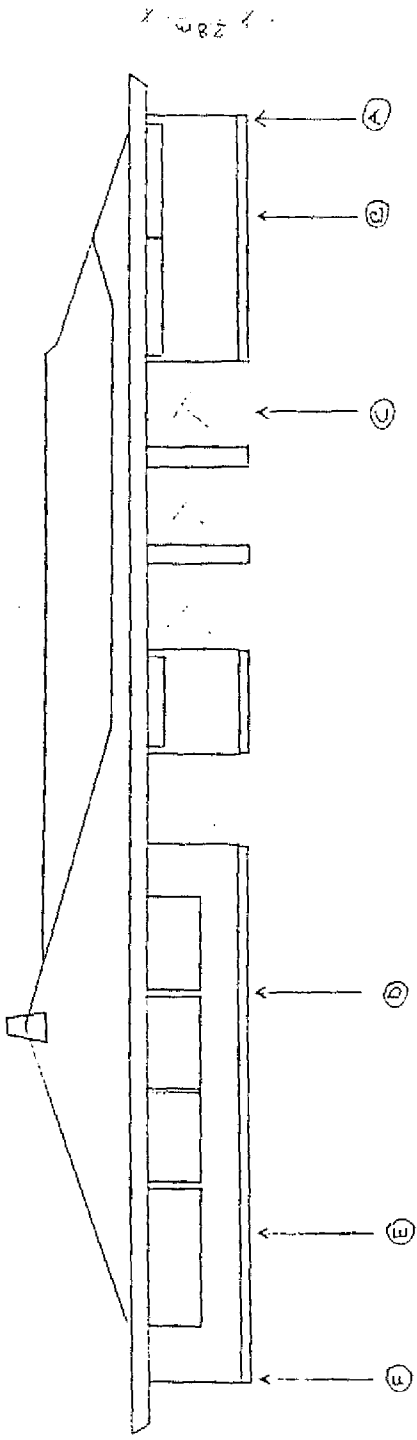

Elevación eje 9

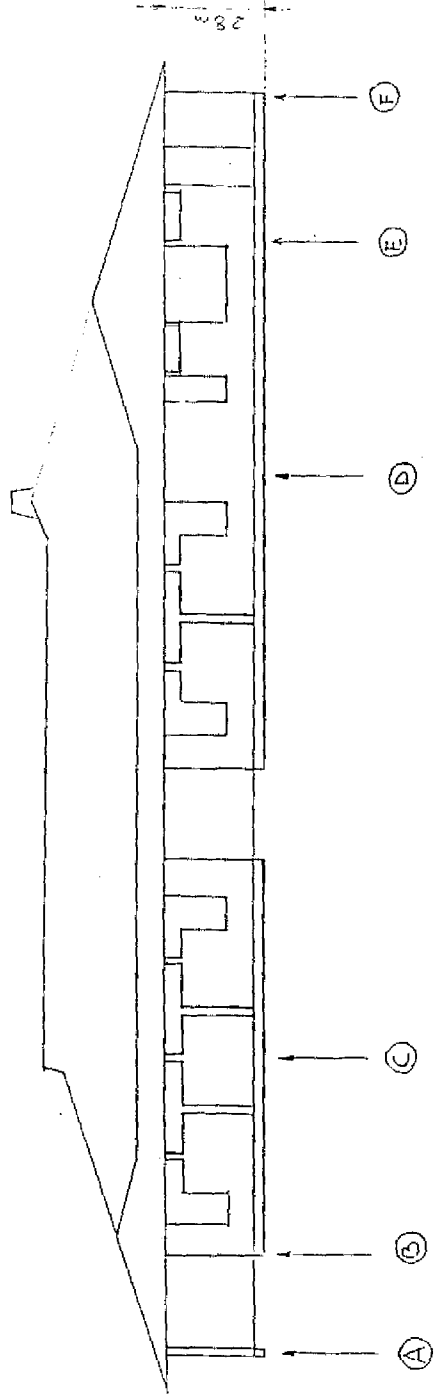

Elevación eje 1

HOSPITAL DE PUERTO MONTT
CUERPO L

Elevación eje F

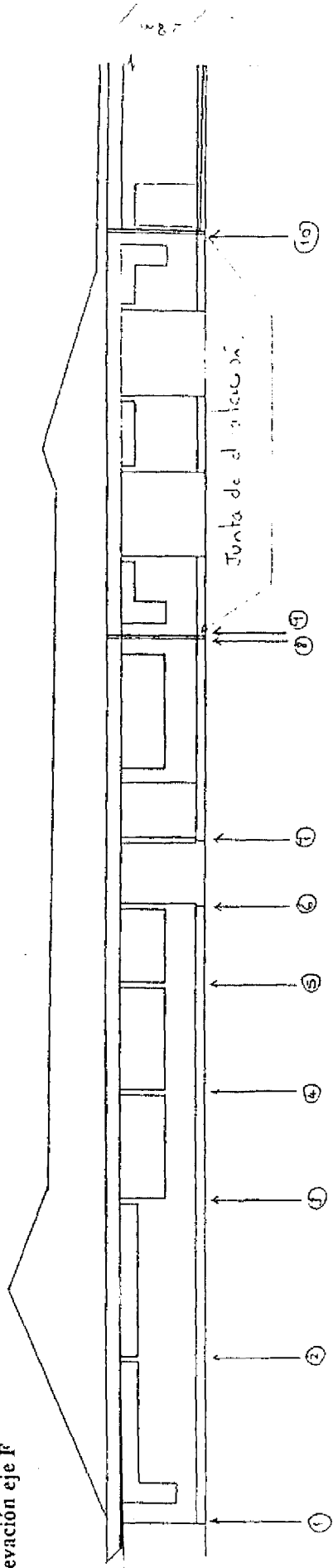

Elevación eje A

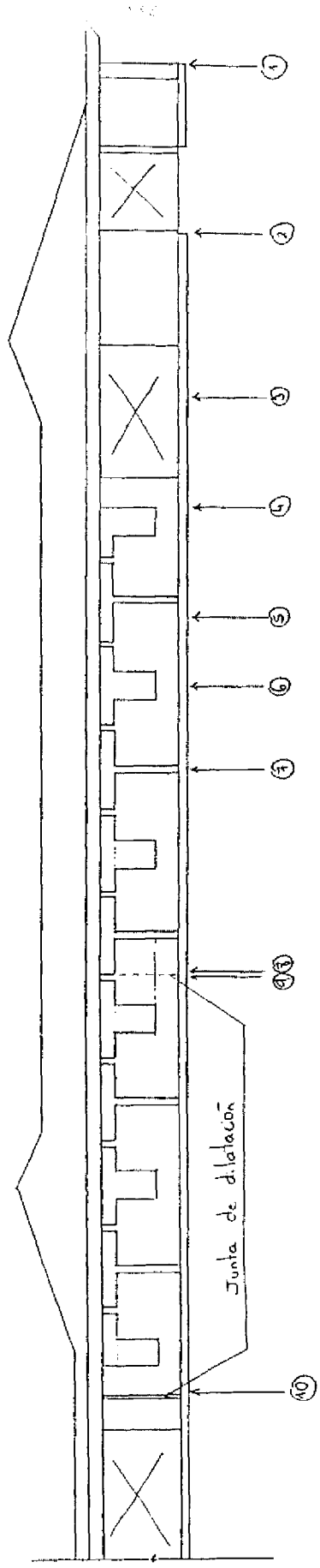

HOSPITAL DE PUERTO MONTT
CUERPO L

Elevación corte A-A

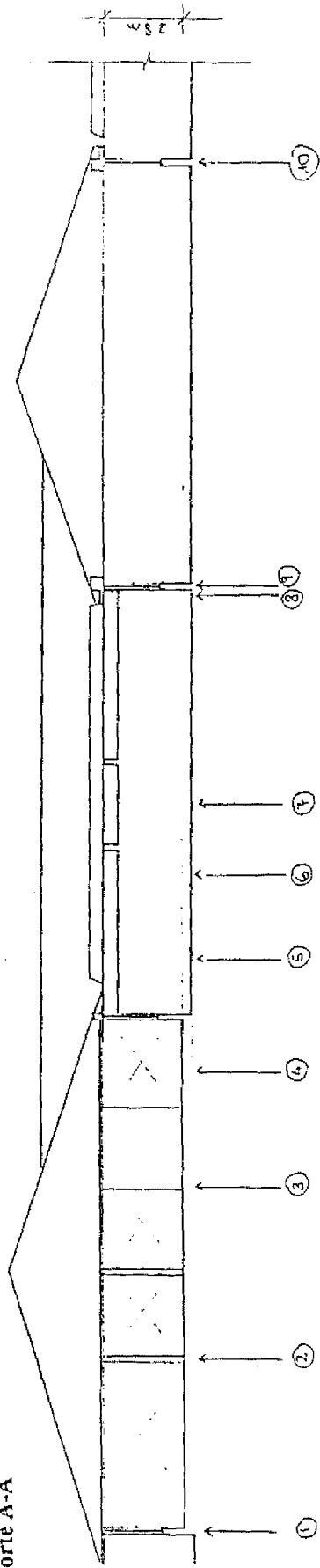

Elevación corte B-B

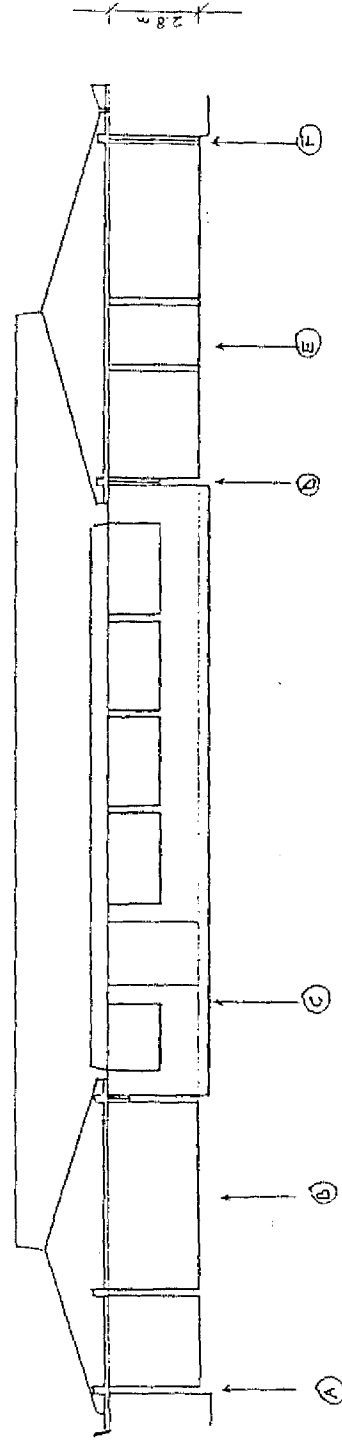

HOSPITAL DE PUERTO MONTE
CUERPO M

Elevación eje A

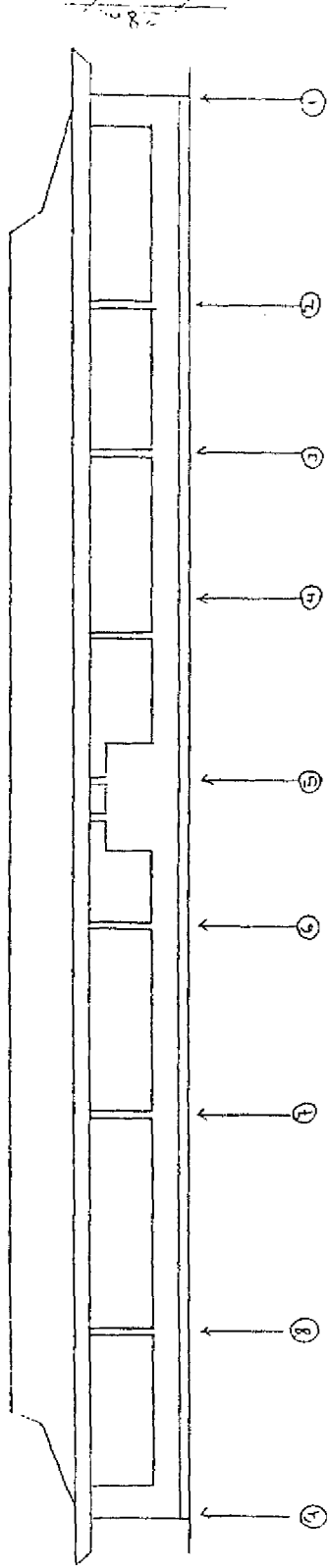

Elevación eje C

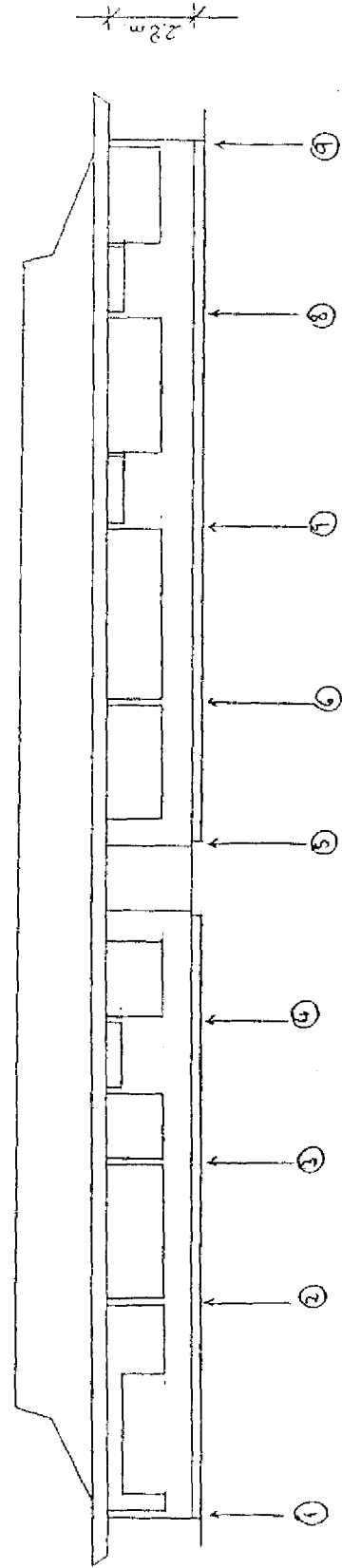

HOSPITAL DE PUERTO MONTT
CUERPO M

Elevación eje 9

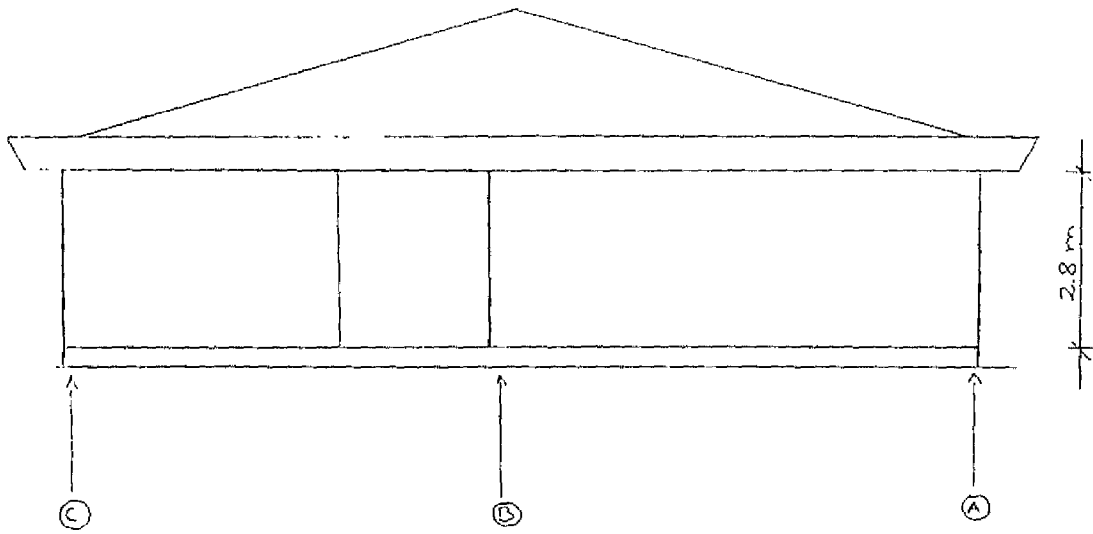

Elevación eje 1

